

LED PROFILE SLIM8 AC2/Z 2000 ANOD.







Surface



Furniture



max 8 mm

	<ul style="list-style-type: none"> • universal application • Slick socket • painted mounting plates 	 CE  EU industrial designs  Made in Poland	 Buy product
---	--	---	--

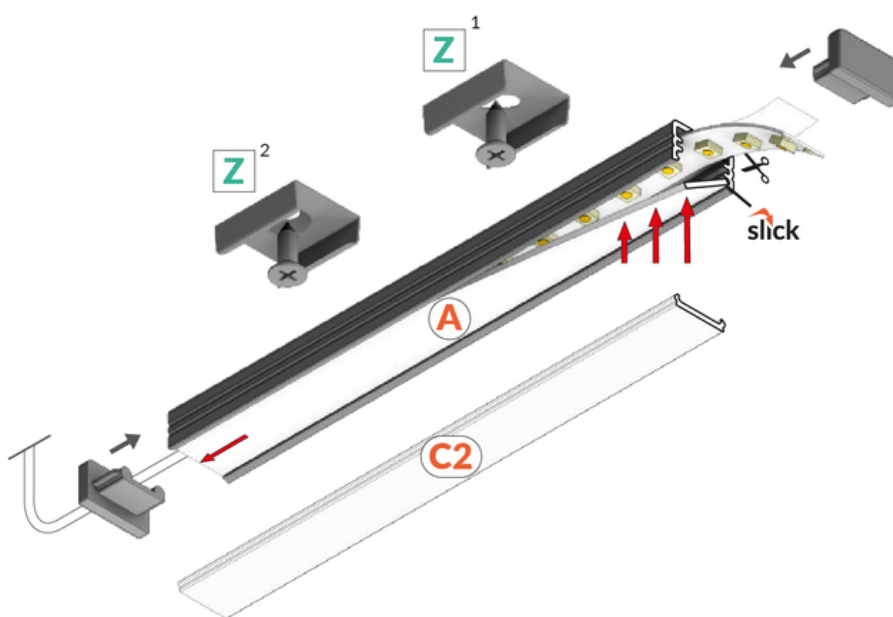
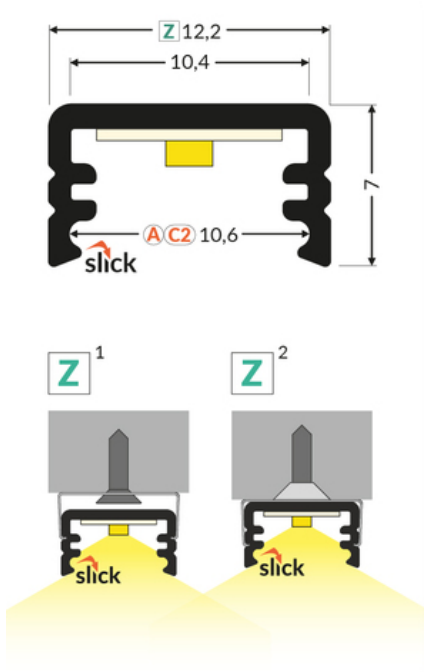

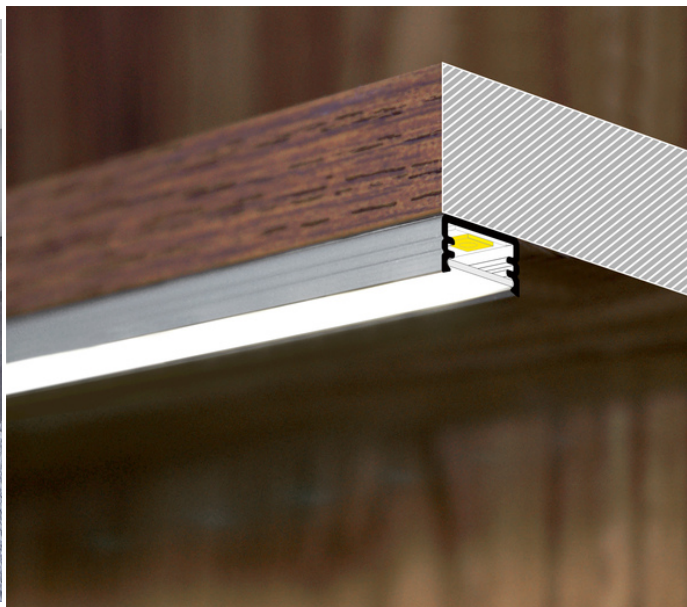

Basic Informations

EAN: 5901597201113
Index: 89030020
Material: aluminium
Color: anodized
Length [mm]: 2000
Weight [kg]: 0.138
Net weight [kg]: 0.012
Country of origin: TR

Measurement unit: qty
Bulk packing [qty]: 40
Master packaging type: Bulk
Product with gross packaging weight [kg]: 5.52

AVAILABLE COLORS

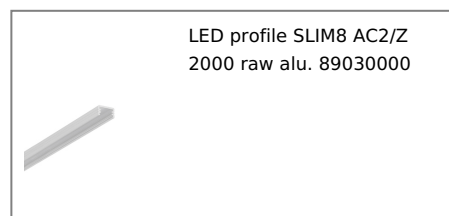
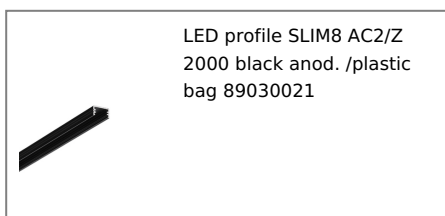

AVAILABLE VARIANTS

1000 mm, 2000 mm, 3000 mm, 4050 mm

Matching elements

DIFFUSERS

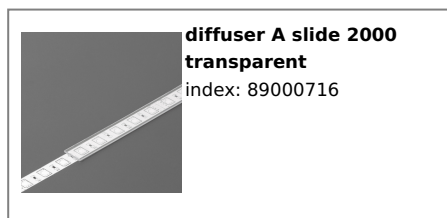
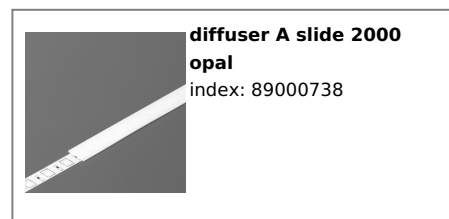
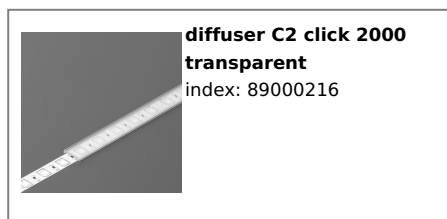
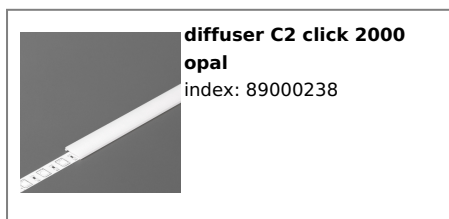

MOUNTINGS



END CAPS

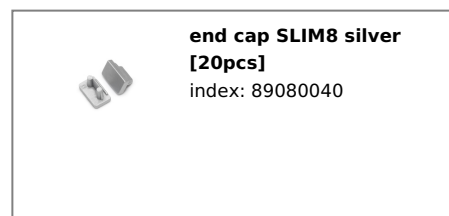
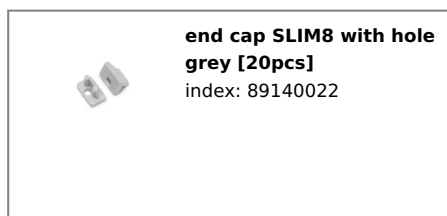
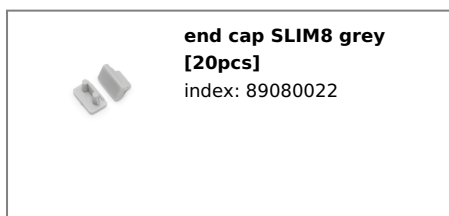



**end cap SLIM8 with hole
silver [20pcs]**
index: 89140040

CONNECTORS



**connector SLIM8 90deg
anod. /plastic bag**
index: 89150020