

# LED PROFILE NAMI23 CD-9 1000 TITANIUM BLUE PAINTED





## /PLASTIC BAG



Lighting

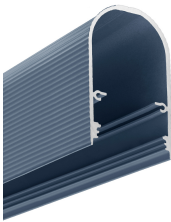

max 23 mm

	<ul style="list-style-type: none"> <li>• for the construction of suspended LED luminaires</li> <li>• unique aesthetics, new design</li> <li>• minimalist and refined details</li> <li>• convenient mounting and service – clip-on profile for LED source</li> <li>• space for the power supply inside the luminaire</li> </ul>	<p> CE</p> <p> EU industrial designs</p> <p> Made in Poland</p>	 <p>Buy product</p>
---	--	--	--

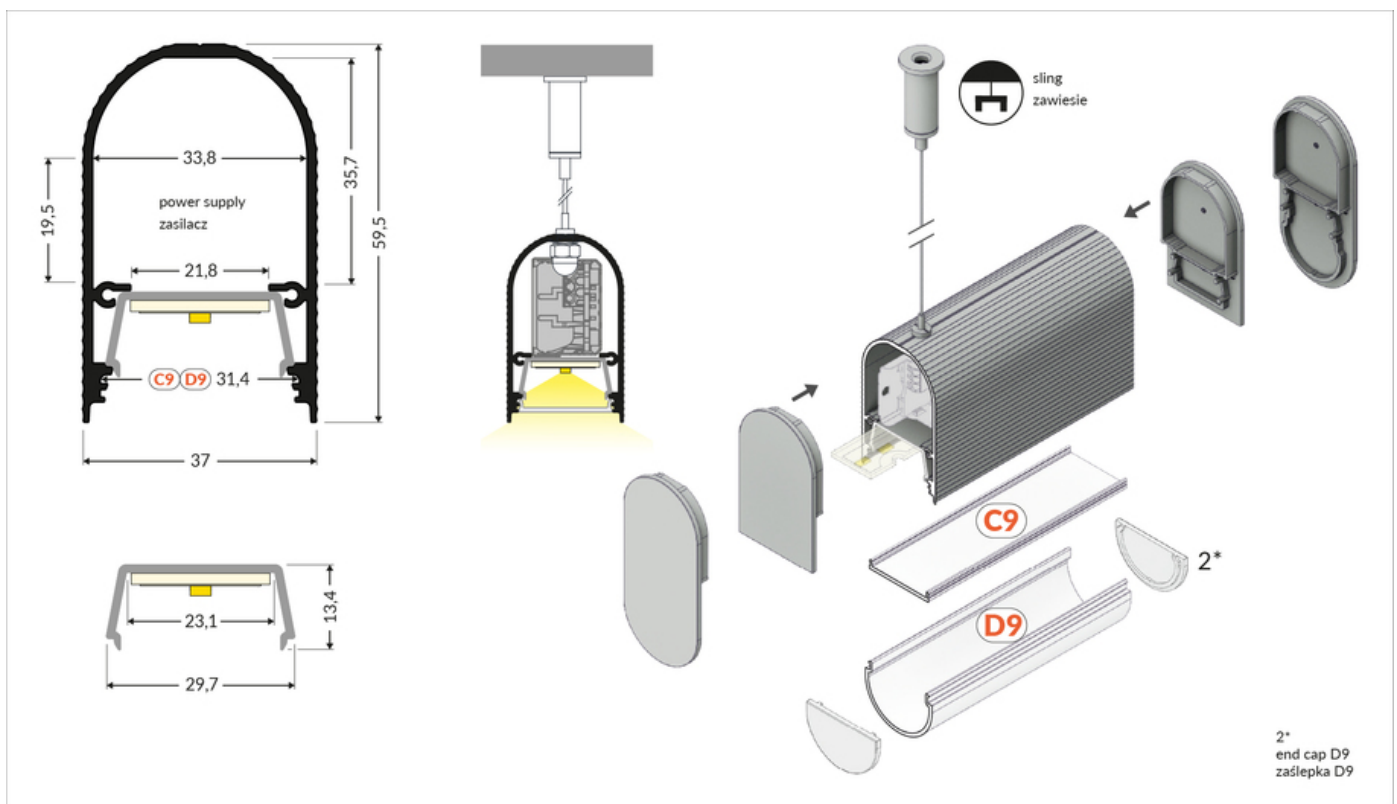

Technical drawing showing dimensions and assembly details of the LED profile:

- Overall height: 59,5
- Top arch height: 33,8
- Power supply height: 19,5
- Power supply width: 21,8
- Bottom width: 37
- LED source height: 13,4
- LED source width: 23,1
- LED source depth: 29,7
- LED source height (with profile): 31,4
- LED source width (with profile): 31,4
- LED source depth (with profile): 29,7

Assembly details include:

- power supply zasilacz
- LED source (C9 D9)
- sling zawiesie
- end cap D9 (2\*)
- zaślepka D9

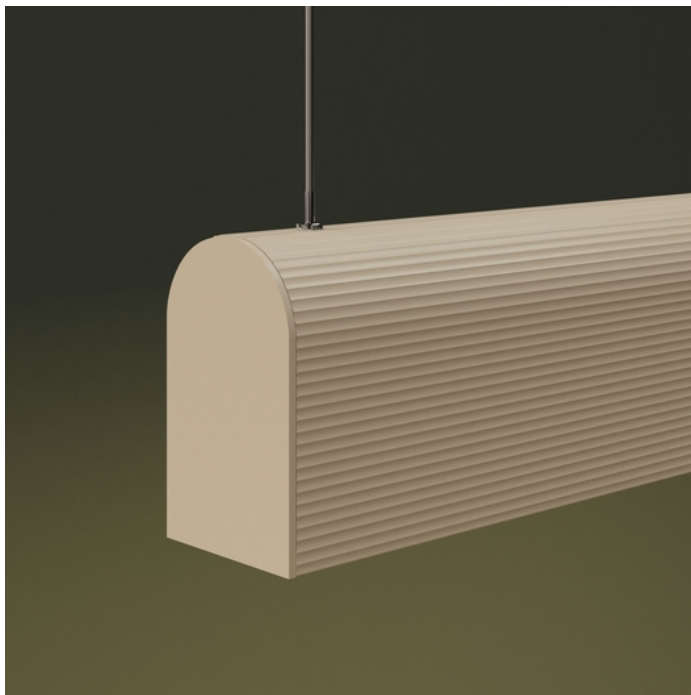

## Basic Informations

Material: aluminium Color: titanium blue (RAL 250 50 15) Length [mm]: 1000 Weight [kg]: 0.674 Net weight [kg]: 0.015 Country of origin: PL	Measurement unit: qty Product packaging dimensions [mm]: 1000 x 37 x 59,5 Bulk packing [qty]: 10 Master packaging type: Bulk Product with gross packaging weight [kg]: 6.74
---	---

## AVAILABLE COLORS

 <p>LED profile NAMI23 CD-9 1000 white painted /plastic bag K1000101</p>	 <p>LED profile NAMI23 CD-9 1000 black anod. /plastic bag K1000121</p>	 <p>LED profile NAMI23 CD-9 1000 slate pink painted /plastic bag K1000195</p>
 <p>LED profile NAMI23 CD-9 1000 almond beige painted /plastic bag K1000196</p>	 <p>LED profile NAMI23 CD-9 1000 medium black painted /plastic bag K1000194</p>	 <p>LED profile NAMI23 CD-9 1000 raw alu. K1000100</p>

## AVAILABLE VARIANTS

1000 mm, 2000 mm

## Matching elements

## DIFFUSERS

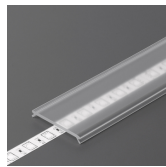
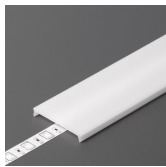
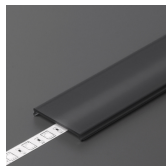
 <p>diffuser C9 click 1000 transparent /plastic bag index: V3450016</p>	 <p>diffuser C9 click 1000 opal /plastic bag index: V3450038</p>	 <p>diffuser C9 click 1000 black /plastic bag index: V3450041</p>
--	---	--



**diffuser D9 click 1000  
opal /plastic bag**  
index: V3490038

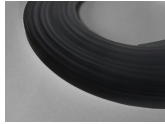

**diffuser C9 click 20m  
reel black**  
index: V3000441S

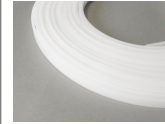

**diffuser C9 click IRM  
20m reel opal**  
index: V3000938S

---

## END CAPS



**end cap NAMI23 metal  
titanium blue painted  
[2pcs]**  
index: K1999697



**end cap NAMI23-D9  
metal titanium blue  
painted [2pcs]**  
index: K1999797

---

## SLINGS



**sling large 1500 chrome  
/plactic bag**  
index: 43100003

---

## COMPLEMENTARY PROFILE

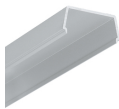

**complementary profile  
NAMI23 1000 anod.**  
index: K1000520