

LED PROFILE NAMI23 CD-9 2000 SLATE PINK PAINTED





/PLASTIC BAG



Lighting



max 23 mm

	<ul style="list-style-type: none"> • for the construction of suspended LED luminaires • unique aesthetics, new design • minimalist and refined details • convenient mounting and service – clip-on profile for LED source • space for the power supply inside the luminaire 	<p> CE</p> <p> EU industrial designs</p> <p> Made in Poland</p>	 <p>Buy product</p>
---	--	--	--

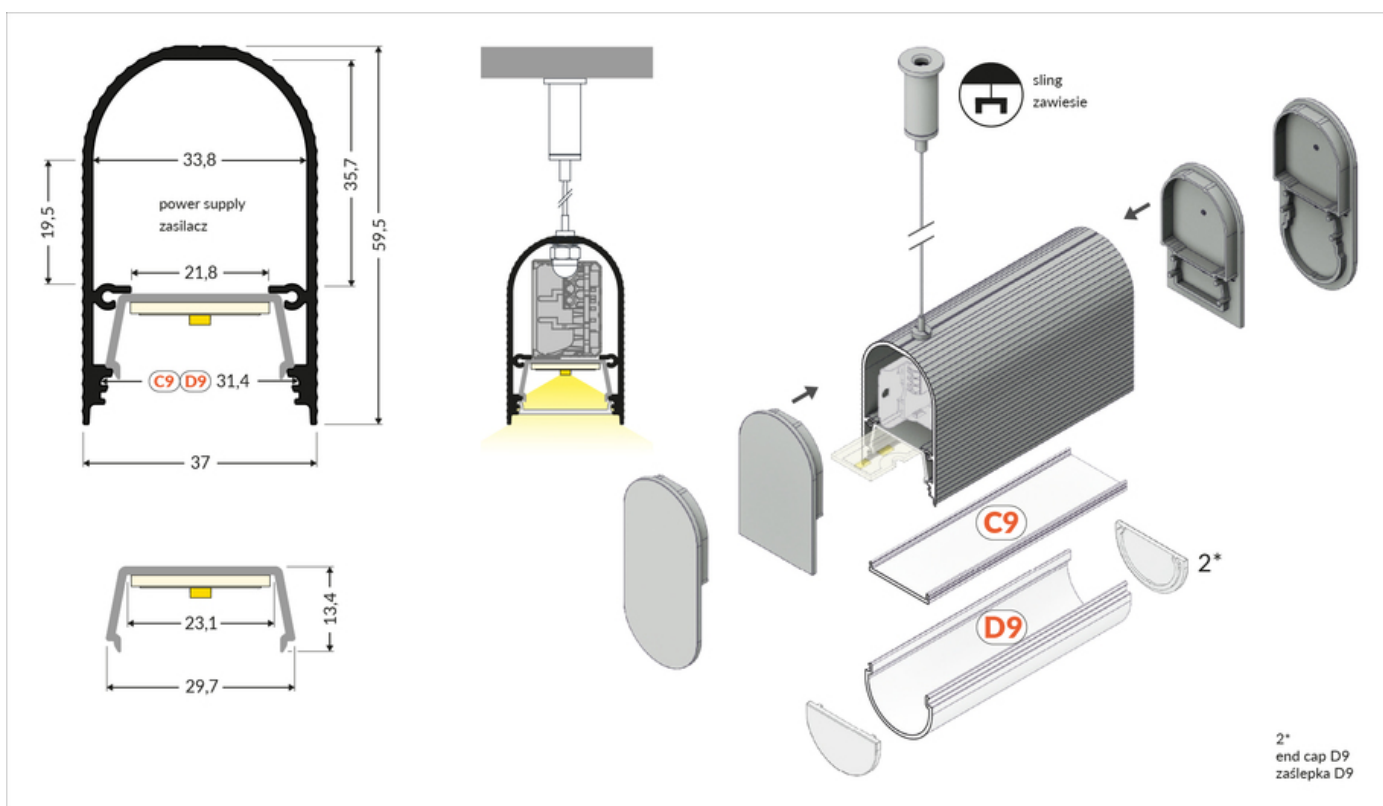

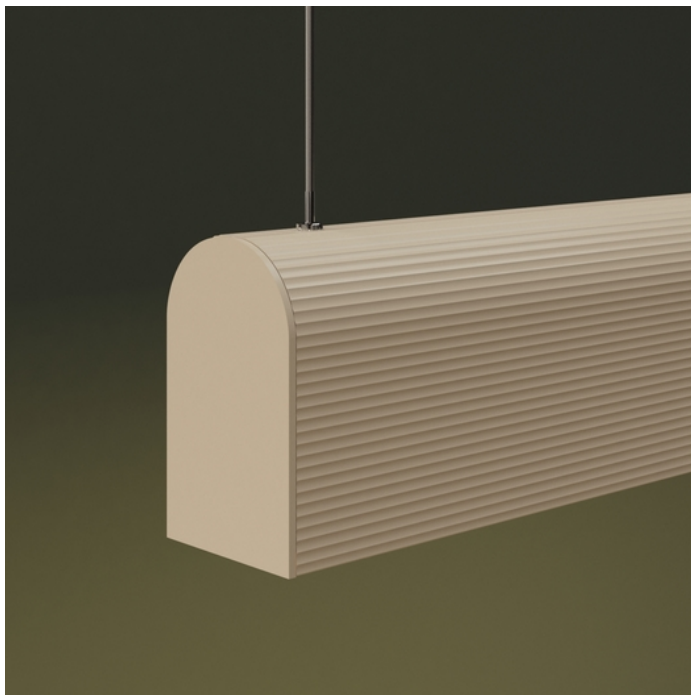





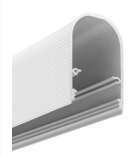

Basic Informations

Material: aluminium Color: slate pink (RAL 010 50 40) Length [mm]: 2000 Weight [kg]: 1.348 Net weight [kg]: 0.015 Country of origin: PL	Measurement unit: qty Product packaging dimensions [mm]: 2000 x 37 x 59,5 Bulk packing [qty]: 10 Master packaging type: Bulk Product with gross packaging weight [kg]: 13.48
--	--

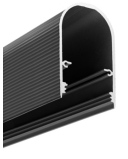
AVAILABLE COLORS

 <p>LED profile NAMI23 CD-9 2000 white painted /plastic bag K1000201</p>	 <p>LED profile NAMI23 CD-9 2000 titanium blue painted /plastic bag K1000297</p>	 <p>LED profile NAMI23 CD-9 2000 black anod. /plastic bag K1000221</p>
 <p>LED profile NAMI23 CD-9 2000 almond beige painted /plastic bag K1000296</p>	 <p>LED profile NAMI23 CD-9 2000 medium black painted /plastic bag K1000294</p>	 <p>LED profile NAMI23 CD-9 2000 raw alu. K1000200</p>

AVAILABLE VARIANTS

1000 mm, 2000 mm

Matching elements

DIFFUSERS

 <p>diffuser C9 click 2000 transparent /plastic bag index: V3460016</p>	 <p>diffuser C9 click 2000 black /plastic bag index: V3460041</p>	 <p>diffuser D9 click 2000 opal /plastic bag index: V3500038</p>
--	--	---

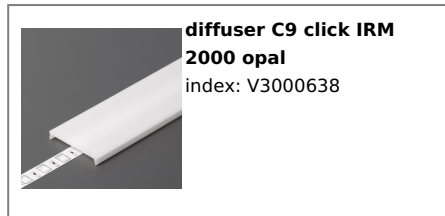

END CAPS

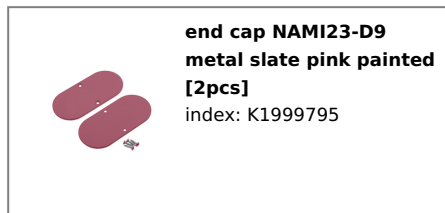
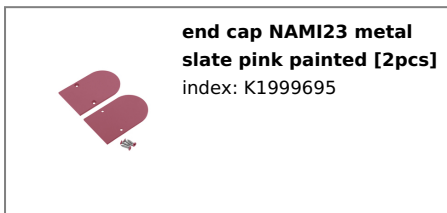

SLINGS

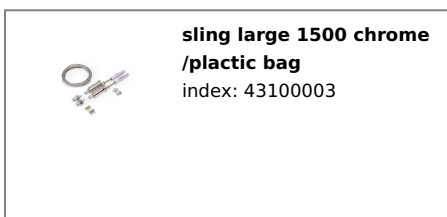

COMPLEMENTARY PROFILE

