

LED PROFILE PHIL53 C10 2000 WHITE PAINTED /PLASTIC BAG

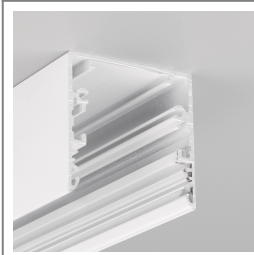

- profile for creating LED luminaires
- perfect as main lighting
- various installation options
- larger sizes
- 3 types of covers available with different light distributions
- enables hiding the power supply inside the profile



EU industrial designs



CE



Made in Poland



Buy product

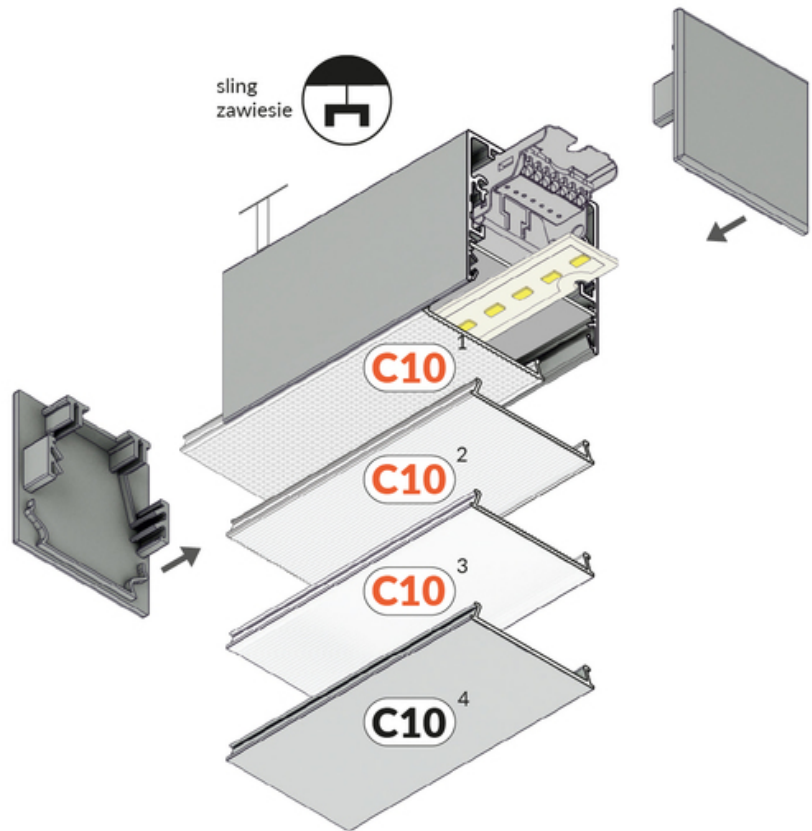
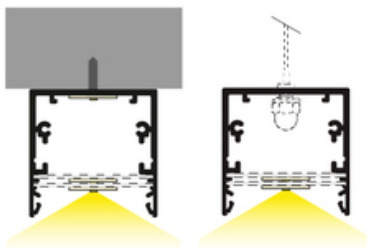
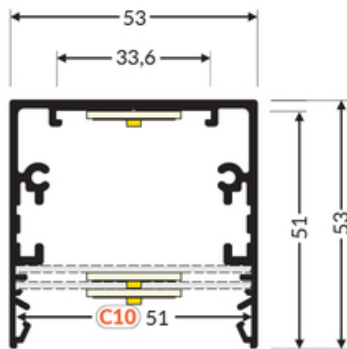

TOPMET LIGHT KŁOSOWICZ WIŚNIEWSKI sp. z o.o.

Ostrowska 354 | 61-312 Poznań | POLAND

tel.: +48 61 872 75 00

info@topmet.pl

pdf card generation date: 10.03.2025





Basic Informations

EAN: 5901597200802 Index: 63530001 Material: aluminium Color: white painted Length [mm]: 2000 Weight [kg]: 1.995 Net weight [kg]: 0.018 Country of origin: PL	Measurement unit: qty Product packaging dimensions [mm]: 2000 x 53 x 53 Bulk packing [qty]: 6 Master packaging type: Carton Product with gross packaging weight [kg]: 13.67
--	---

AVAILABLE COLORS

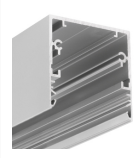
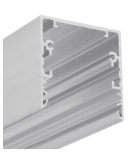
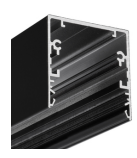
 <p>LED profile PHIL53 C10 2000 anod. /plastic bag 63530020</p>	 <p>LED profile PHIL53 C10 2000 raw alu. 63530000</p>	 <p>LED profile PHIL53 C10 2000 black painted /plastic bag 63530002</p>
--	--	--

AVAILABLE VARIANTS

1000 mm, 2000 mm, 3000 mm, 4050 mm

Matching elements

DIFFUSERS

 <p>diffuser C10 click 2000 wide index: 63590000</p>	 <p>diffuser C10 click 2000 narrow index: 63620000</p>	 <p>diffuser C10 click 2000 opal index: 63690038</p>
 <p>diffuser C10 click 2000 pro index: P2001016</p>	 <p>diffuser C10 click 2000 basic index: P2001438</p>	

END CAPS

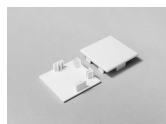

end cap PHIL53 white
/plastic bag [2pcs]
index: 63640001

COMPLEMENTARY PROFILE

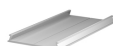

cover C10 2000 anod.
index: 63560020



cover C10 2000 white
painted /plastic bag
index: 63560001



cover C10 2000 black
painted /plastic bag
index: 63560002



cover C10 2000 raw alu.
index: 63560000