

# LED PROFILE GROOVE14 EE7F/TY 2000 ANOD.







Recessed



Furniture



max 14 mm

	<ul style="list-style-type: none"> <li>• used mainly in furniture</li> <li>• many accessories available</li> </ul>	 EU industrial designs  CE  Made in Poland	 Buy product
---	--	---	--

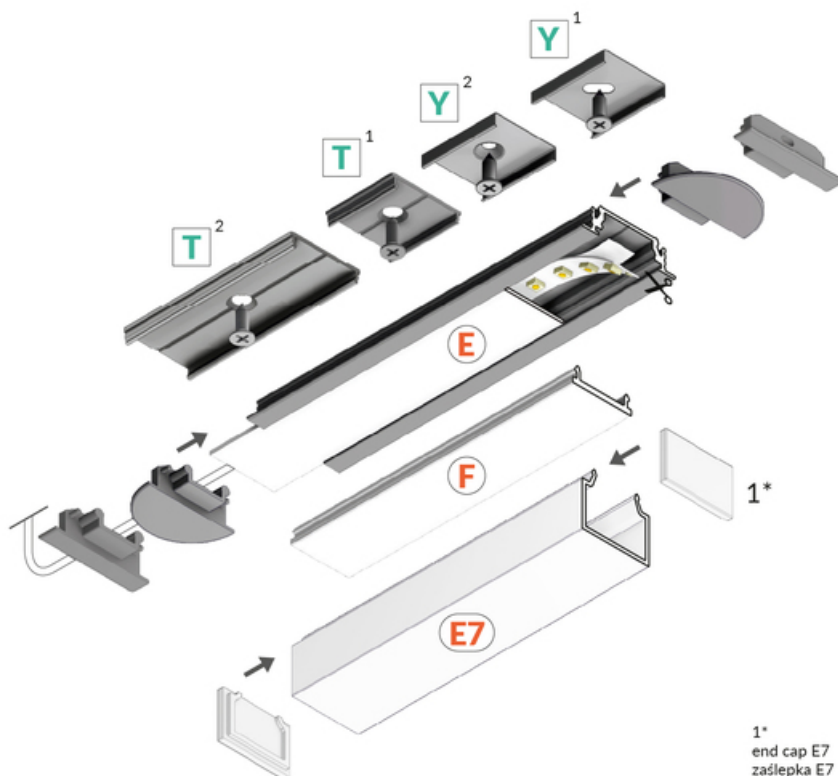
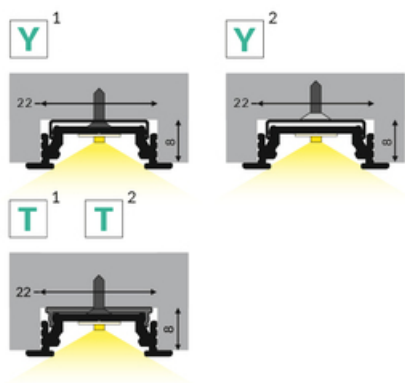
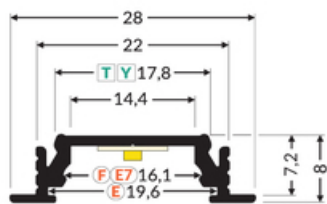





## Basic Informations

<p>EAN: 5901597205043          Index: A3020020          Material: aluminium          Color: anodized          Length [mm]: 2000          Weight [kg]: 0.298          Net weight [kg]: 0.018          Country of origin: PL</p>	<p>Measurement unit: qty          Product packaging dimensions [mm]: 2000 x 28 x 8          Bulk packing [qty]: 40          Master packaging type: Bulk          Product with gross packaging weight [kg]: 11.92</p>
--	--

## AVAILABLE COLORS

 <p>LED profile GROOVE14          EE7F/TY 2000 white painted          /plastic bag A3020001</p>	 <p>LED profile GROOVE14          EE7F/TY 2000 raw al.          A3020000</p>	 <p>LED profile GROOVE14          EE7F/TY 2000 black anod.          /plastic bag A3020021</p>
--	---	--

## AVAILABLE VARIANTS

1000 mm, 2000 mm, 3000 mm, 4050 mm

## Matching elements

## DIFFUSERS

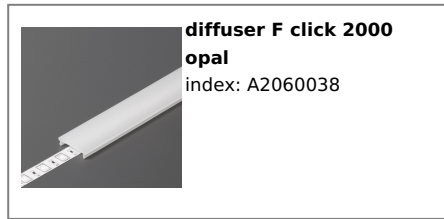

## MOUNTINGS

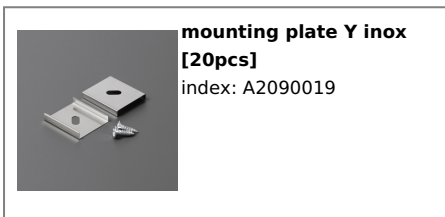
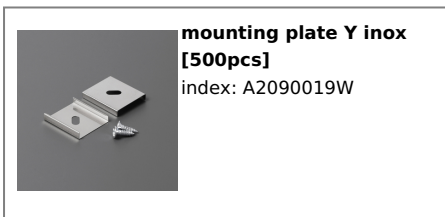

## END CAPS

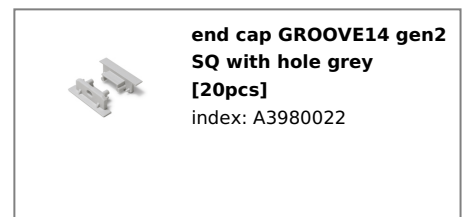
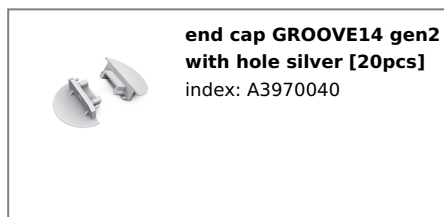
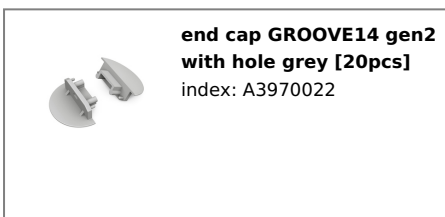

TOPMET LIGHT KŁOSOWICZ WIŚNIEWSKI sp. z o.o.

Ostrowska 354 | 61-312 Poznań | POLAND

tel.: +48 61 872 75 00

info@topmet.pl

pdf card generation date: 10.03.2025





**end cap GROOVE14 gen2  
SQ with hole silver  
[20pcs]**  
index: A3980040

---

## CONNECTORS



**connector GROOVE14  
90deg anod. /plastic bag**  
index: A3990020



**connector T 180deg  
/plastic bag**  
index: C6990000



**connector T 180deg  
/plastic bag [200pcs]**  
index: C6990000W