

LED PROFILE GROOVE14.V2 BC3/Y 2000 ANOD.





Recessed



Furniture



max 14 mm

	<ul style="list-style-type: none"> • a new generation of recessed profiles • basic and aesthetically pleasing furniture profile • shallow mounting hole depth 	<p>CE CE</p> <p>EU industrial designs</p> <p>PL Made in Poland</p>	 <p>Buy product</p>
---	--	--	--

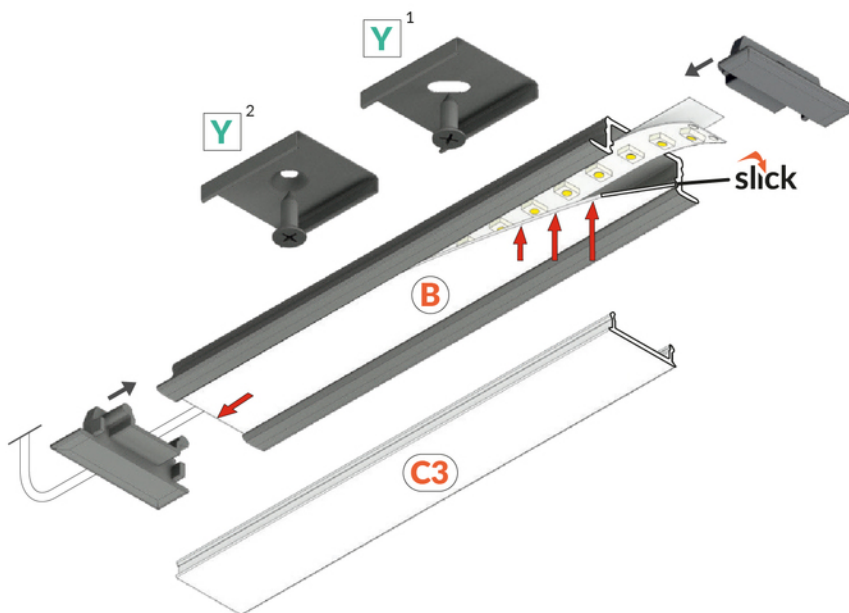
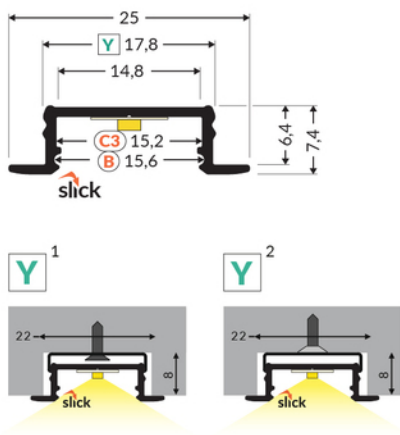



Basic Informations

EAN: 5901597232063
 Index: K6000220
 Material: aluminium
 Color: anodized
 Length [mm]: 2000
 Weigh [kg]: 0.214
 Net weight [kg]: 0.024
 Country of origin: PL

Measurement unit: qty
 Product packaging dimensions [mm]: 2000 x 25 x 7,4
 Bulk packing [qty]: 40
 Master packaging type: Bulk
 Product with gross packaging weight [kg]: 8.56

AVAILABLE COLORS

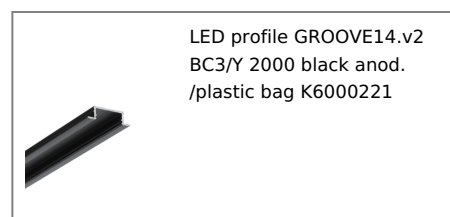
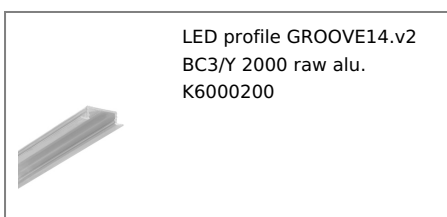

AVAILABLE VARIANTS

2000 mm, 4050 mm

Matching elements

TOPMET LIGHT KŁOSOWICZ WIŚNIEWSKI sp. z o.o.
 Ostrowska 354 | 61-312 Poznań | POLAND
 tel.: +48 61 872 75 00
 info@topmet.pl

pdf card generation date: 10.03.2025



DIFFUSERS

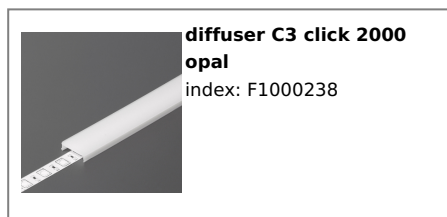

MOUNTINGS



END CAPS

