

LED PROFILE VARIO30-05 ACDE-9 2000 ANOD.



Spackle in



Architectural



Lighting

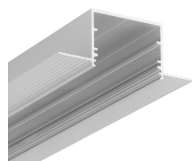

CE



EU industrial designs



Made in Poland



Buy product

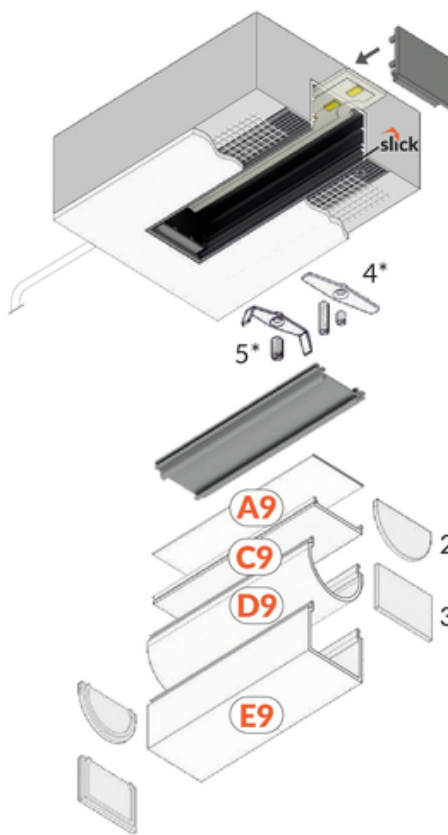
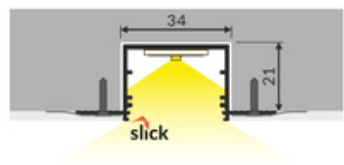
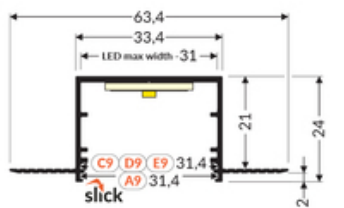

2*
end cap D9
zaslepka D9

3*
end cap E9
zaslepka E9

4*
LED clamp VARIO30
docisk LED VARIO30

5*
LED clamp VARIO30-1
docisk LED VARIO30-1



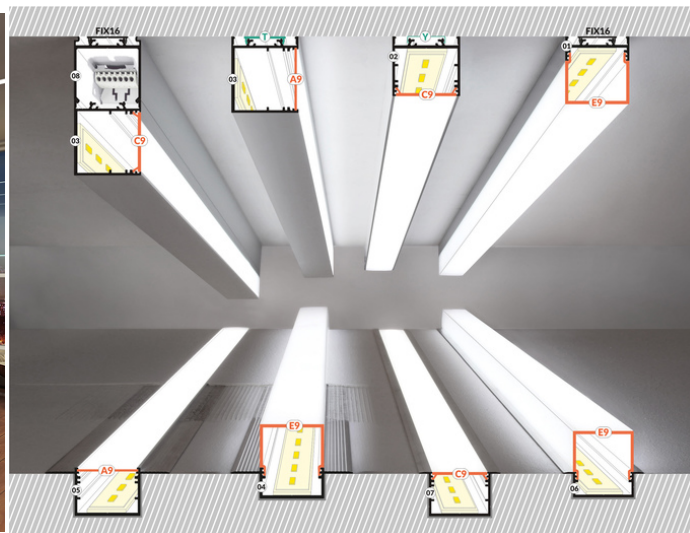

Basic Informations

EAN: 5901597240198
 Index: V3180020
 Material: aluminium
 Color: anodized
 Length [mm]: 2000
 Weight [kg]: 0.75
 Country of origin: PL

Measurement unit: qty
 Product packaging dimensions [mm]: 2000 x 63,4 x 24
 Bulk packing [qty]: 20
 Master packaging type: Bulk
 Product with gross packaging weight [kg]: 15

AVAILABLE COLORS

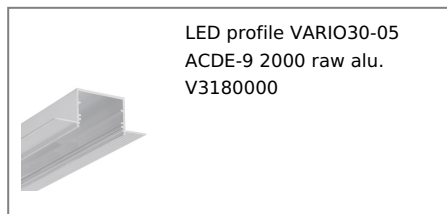

AVAILABLE VARIANTS

1000 mm, 2000 mm, 3000 mm, 4050 mm

Matching elements

DIFFUSERS

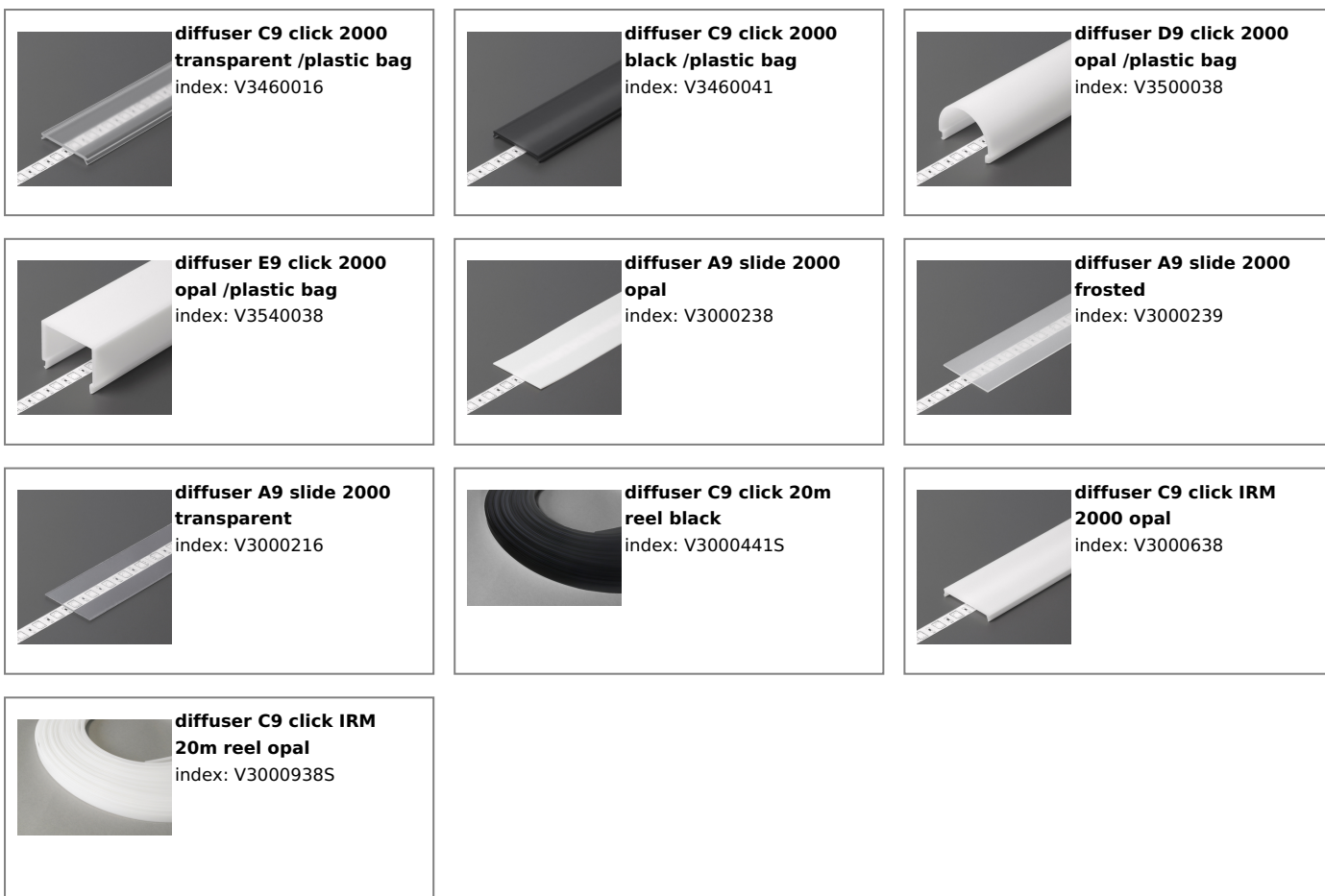

END CAPS



CONNECTORS

TOPMET LIGHT KŁOSOWICZ WIŚNIEWSKI sp. z o.o.

Ostrowska 354 | 61-312 Poznań | POLAND

tel.: +48 61 872 75 00

info@topmet.pl

pdf card generation date: 10.03.2025





**connector VARIO30-05
60deg anod. /plastic bag**
index: V4720020S



**connector VARIO30-05
90deg anod. /plastic bag**
index: V4730020S



**connector VARIO30-05
90deg bent anod.
/plastic bag**
index: V4740020S



**connector VARIO30-05
120deg anod. /plastic
bag**
index: V4750020S



**connector VARIO30-05
135deg anod. /plastic
bag**
index: V4760020S



**connector VARIO30-05
180deg /plastic bag**
index: V4650000s



**connector VARIO30-05
270deg bent anod.
/plastic bag**
index: V4770020S