

PLANE14 IN BC3

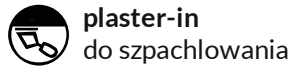

1 DIMENSIONS / WYMIARY

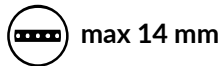
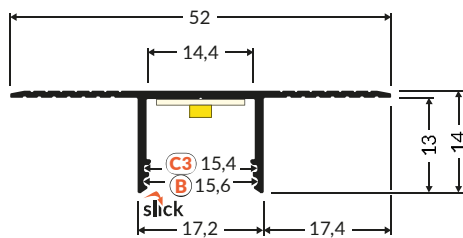

2 MOUNTING / MONTAŻ

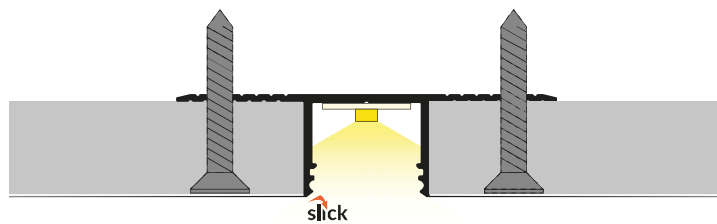

3 COMPONENTS ELEMENTY SKŁADOWE

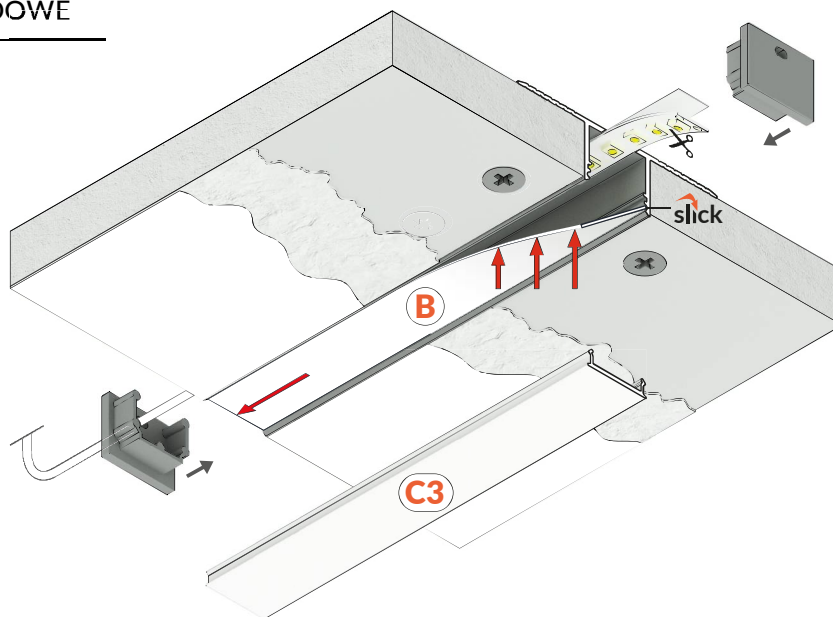

B
diffuser B slide
klosz B wsuwany

C3
diffuser C3 click
klosz C3 klik



scissors nożyczki saw piła pliers kombinierki solder cyna soldering iron lutownica screwdriver wkrętak drill wiertarka spatula szpachelka painting roller wałek malarski

LENGTHS / DŁUGOŚCI

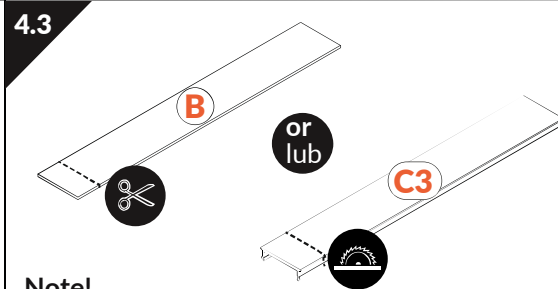
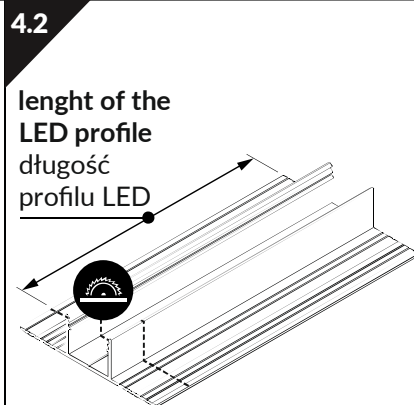
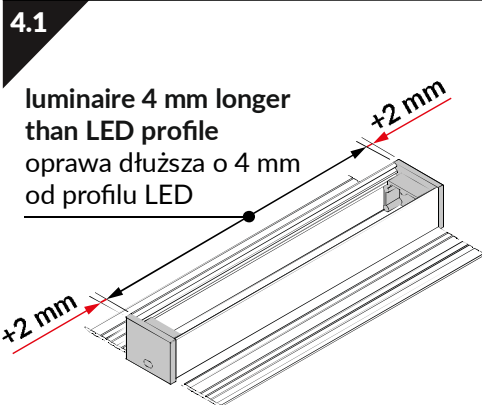

Note!
Due to the thermal expansion of the material we recommend cutting the diffuser at least 1 mm shorter depending on various factors (e.g. power of source, room temperature).

Uwaga!
Ze względu na rozszerzalność cieplną tworzywa, rekomendujemy skrócić klosz min. o 1 mm. Uwzględnić należy różne czynniki, m.in. moc źródła, temperaturę otoczenia.

DIMENSIONS OF THE SPACE TO INSTALL LED SOURCE WYMIARY PRZESTRZENI DO ZAMONTOWANIA ŹRÓDŁA LED

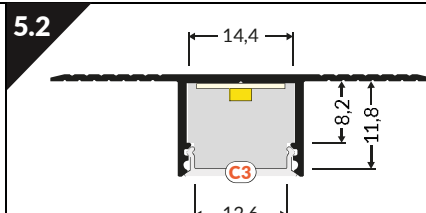
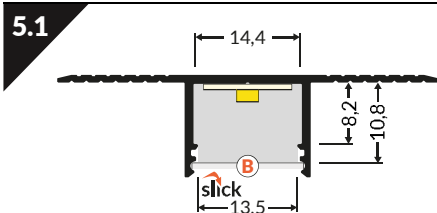

MOUNTING OF THE LED SOURCE / MONTAŻ ŹRÓDŁA ŚWIATŁA

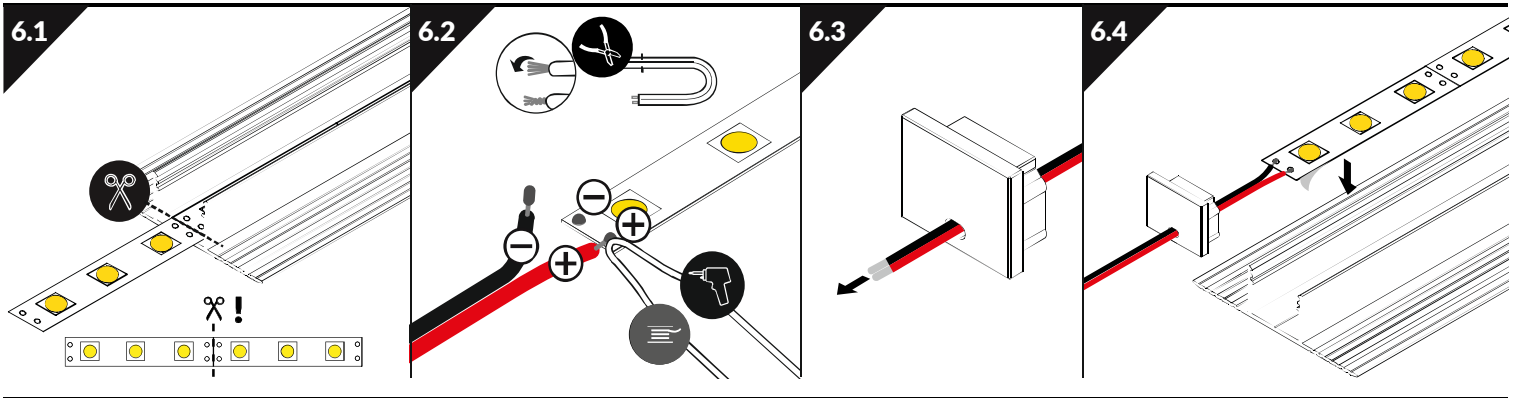

MOUNTING OF THE DIFFUSERS MONTAŻ KLOSZY

MOUNTING OF THE END CAPS MONTAŻ ZAŚLEPEK

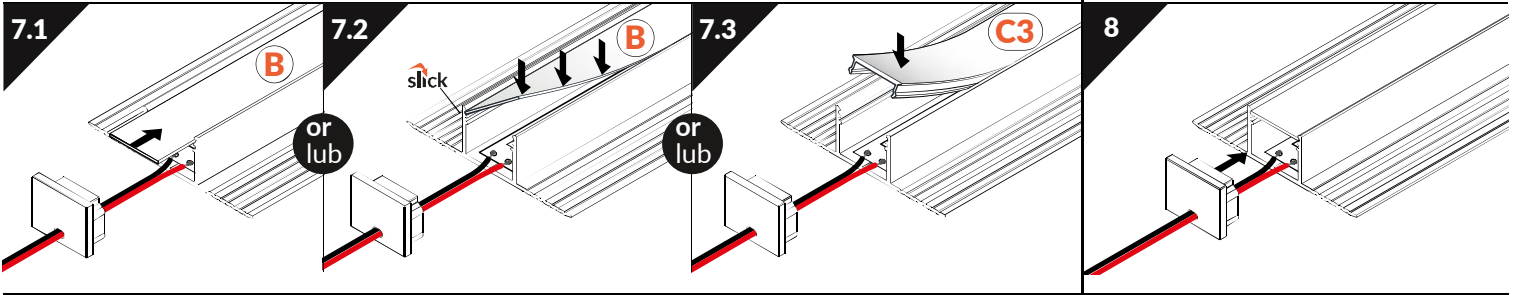

ASSEMBLY OF THE PROFILES IN THE PLASTERBOARD, DRILLING AND SCREW-FIXING

MONTAŻ PROFILU W PŁYTCIE GK,
WYKONANIE OTWORÓW
I MOCOWANIE NA WKRĘTY

FINISHING OF THE ASSEMBLY SURFACE WITH FILLER AND PAINT

WYKOŃCZENIE POWIERZCHNI
MONTAŻOWEJ GŁADZIĄ
SZPACHLOWĄ ORAZ FARBĄ

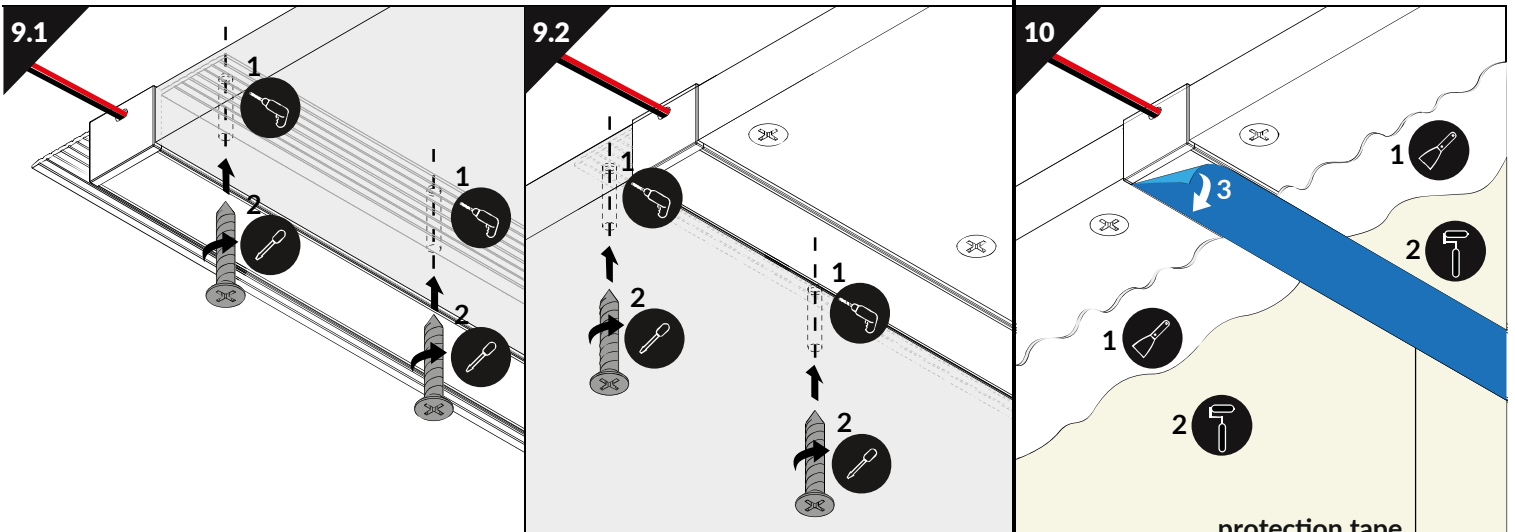

Recommended use of screws for plaster-cardboard

Recommended screws spacing 50 cm

Rekomendowane zastosowanie
wkęć do płyt gipsowo-kartonowych

Zalecane rozmieszczenie wkrętów co 50 cm

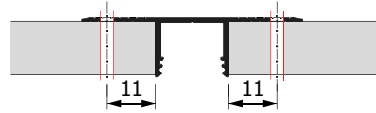

protection tape
taśma ochronna

11 POWER SUPPLY / ZASILANIE

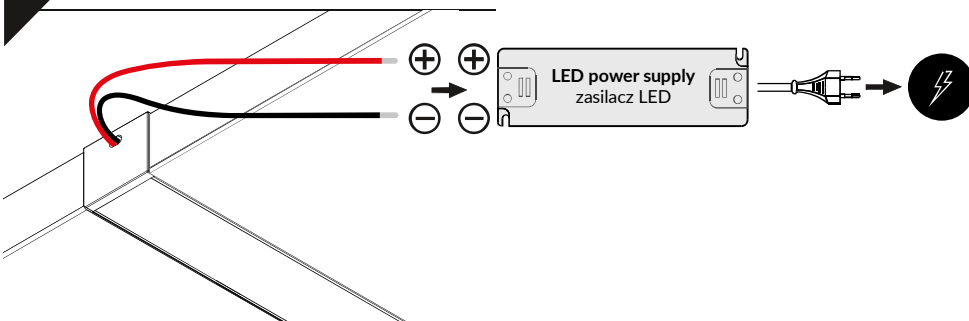

TOPMET Light Kłosowicz Wiśniewski Sp. z o. o.
Ostrowska 354 | 61-312 Poznań | POLAND
tel.: +48 61 872 75 00
www.topmet.pl

 TOPMET®